



MOKA
wardrobe storage system

BullerTM
by emuca 

COMPOSITIONS

Composizioni . Composiciones . Compositions . Composições

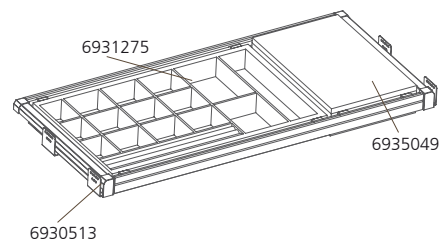
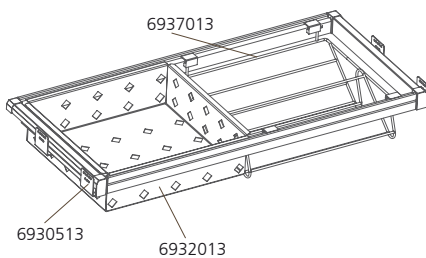
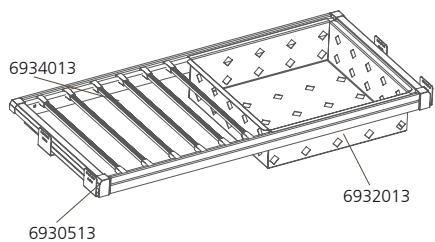
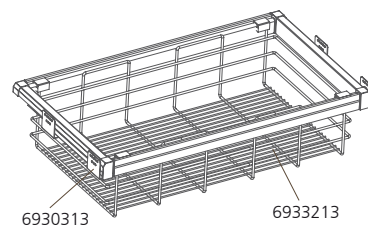
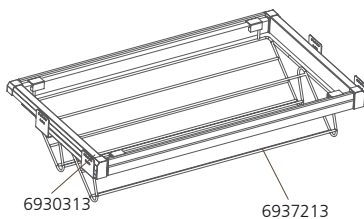
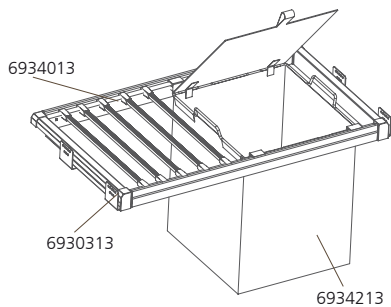
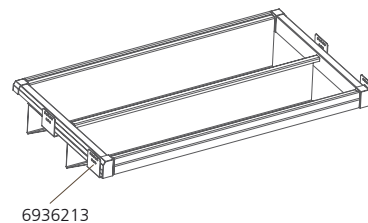
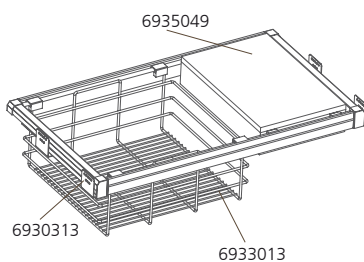
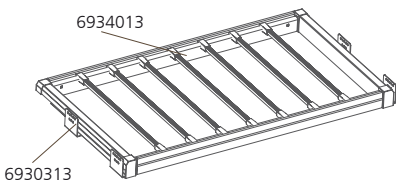
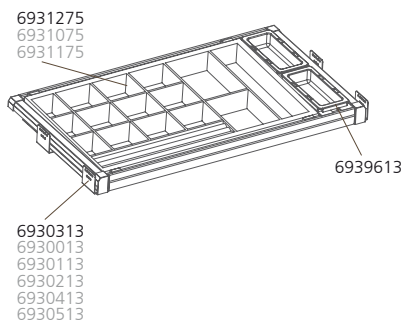
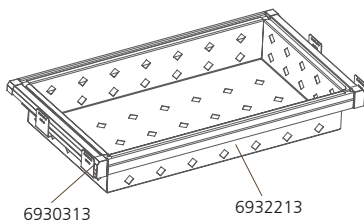
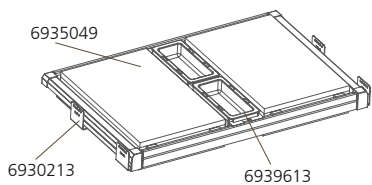

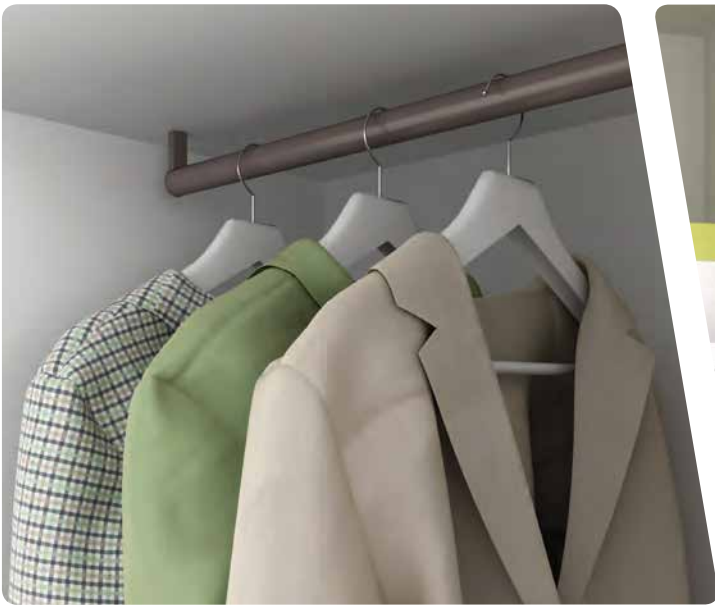



Pull-out hanging rail

Appendiabiti - Colgador abatible

Penderie rabattable - Varão basculante

Rails and supports

Tubi e reggitubi - Tubos y soportes - Tringles et supports - Varões e suportes

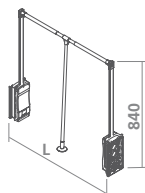

L	Cod.	
450 - 600	69390 13	1
600 - 830	69391 13	1
830 - 1.150	69392 13	1

ST / PL



L	Cod.	
4 m	70141 13	40 m

AL

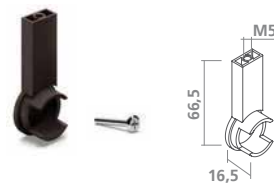
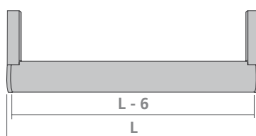

Cod.	
79192 13	200

ZM



MOKA FRAME WITH RUNNERS

Telaio Moka con guide - Bastidor con guías Moka - Cadre coulissant Moka - Bastidor Moka com corredeiras

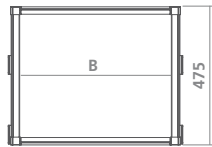
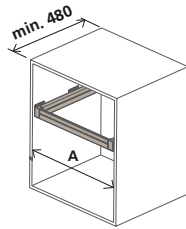

A	B	Cod.	
564 - 614	484 - 534	69300 13	1
664 - 714	584 - 634	69301 13	1
764 - 814	684 - 734	69302 13	1
864 - 914	784 - 834	69303 13	1
964 - 1.014	884 - 934	69304 13	1
1.064 - 1.114	984 - 1.034	69305 13	1

AL / PL

Spacers

Distanziali - Distanciadores

Séparateurs - Distanciadores

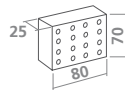

Cod.	
69399 43	1

PL



+



B

A			B
564 - 614	6930013	-	B = A - 80
589 - 639	6930013	1 x 6939943	B = A - 105
614 - 664	6930013	2 x 6939943	B = A - 130
664 - 714	6930113	-	B = A - 80
689 - 739	6930113	1 x 6939943	B = A - 105
714 - 764	6930113	2 x 6939943	B = A - 130
764 - 814	6930213	-	B = A - 80
789 - 839	6930213	1 x 6939943	B = A - 105
814 - 864	6930213	2 x 6939943	B = A - 130
864 - 914	6930313	-	B = A - 80
889 - 939	6930313	1 x 6939943	B = A - 105
914 - 964	6930313	2 x 6939943	B = A - 130
964 - 1.104	6930413	-	B = A - 80
989 - 1.039	6930413	1 x 6939943	B = A - 105
1.014 - 1.064	6930413	2 x 6939943	B = A - 130
1.064 - 1.114	6930513	-	B = A - 80
1.089 - 1.139	6930513	1 x 6939943	B = A - 105
1.114 - 1.164	6930513	2 x 6939943	B = A - 130



Runners included . Guide incluse . Incluye guías . Coulisses compris . Inclui corredeiras

RACK ACCESSORIES MOKA

Accessori per telaio Moka - Accesorios para el bastidor Moka - Accessoires pour cadre coulissant Moka - Acesoários para bastidor Moka

Metallic drawer

Cassetto metallico - Cajón metálico

Panier métallique - Gavetao metálico

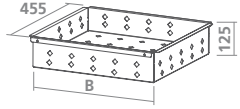

B	Cod.		
475	69320 13	1	
675	69321 13	1	
775	69322 13	1	

ST

Alambra drawer

Cassetto in filo - Cajón de alambre

Panier en fil - Gaveta de arame

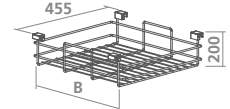

B	Cod.		
475	69330 13	2	
675	69331 13	2	
775	69332 13	2	

ST

Shoe drawer

Porta scarpe - Cajón zapatero

Rangement de chaussures - Cesto sapateira

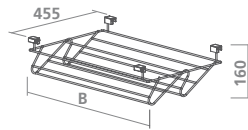
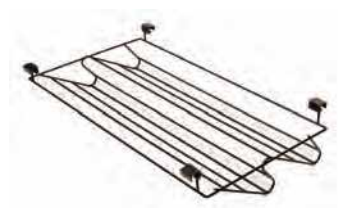

B	Cod.		
475	69370 13	2	
675	69371 13	2	
775	69372 13	2	

ST

Organizer drawer

Cassetto organizzatore - Cajón organizador

Tiroir organisateur - Gaveta organizadora

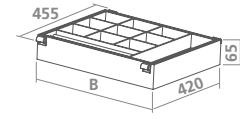

B	Cod.		
483	69310 75	1	
683	69311 75	1	
783	69312 75	1	

Wood

Basket

Cesta - Cesto - Panier - Cesto

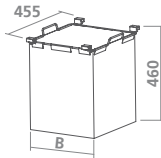

B	Cod.		
355	69342 13	1	

ST

Wooden tray with lid

Cassetto di legno - Cajón de madera

Tiroir en bois - Gaveta de madeira

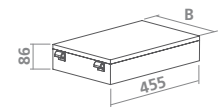

B	Cod.		
270	69350 49	1	

Wood

Auxiliary tray

Vaschetta ausiliare - Bandeja auxiliar

Plateaux auxiliaire - Travessa auxiliar

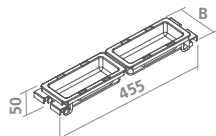

B	Cod.		
99	69396 13	1	

AL / PL

Set of 7 trousers rods

Set di 7 aste porta pantaloni - Juego de 7 varillas pantalonero

Jeu 7 tringles porte-pantalons - Jogo de 7 varetas porta calças



Cod.		
69340 13	1	

AL / PL

AL, ST, PL, WOOD:

Aluminium, Steel, Plastic, Wood. Alluminio, Acciaio, Tecnoplastica, Legno. Aluminio, Acero, Plástico, Madera. Aluminium, Acier, Plastique, Bois. Alumínio, Aço, Plástico, Madeira

MOKA ACCESSORIES

Accessori Moka - Accesorios Moka - Accessoires Moka - Acessórios Moka

Shoe rack with frame*

Portascarpe con telaio - Zapatero con bastidor

Porte-chaussures avec cadre coulissant - Sapateira com bastidor



*Frame included . Telaio incluse
Incluye bastidor . Cadre compris
Inclui bastidor

A	Cod.	
564 - 594	69360 13	1
764 - 794	69361 13	1
864 - 894	69362 13	1

ST

Lateral pull-out shoe rack

Porta scarpe laterale estraibile - Zapatero lateral estraible

Rangement de chaussures latéral extractible - Sapateira lateral extraível

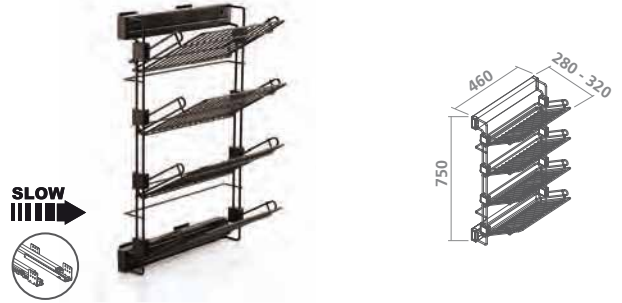

OPTION 1

OPTION 2



	Cod.	
LEFT	69384 13	1
RIGHT	69385 13	1

ST

Pull-out hanging rail

Appendiabiti estraibile - Colgador estraible

Porte-vêtements extractible - Cabide extraível



Cod.	
69387 13	1

AL / PL

Lateral pull-out tie rack*

Porta cravatte laterale estraibile - Corbatero lateral estraible

Porta cravates latéral extractible - Porta gravatas lateral extraível



Cod.	
69388 13	1

AL / PL

* Fastening on both sides . Fissaggio su ambo i lati
Fijación a ambos lados . Fixation sur les deux côtés
Fixação a ambos lados

Mirror for pull-out

Specchio estraibile - Espejo estraible

Miroir extractible - Espelho extraível



Cod.	
69386 13	1

AL / PL



13 Moka painted . Verniciato moka . Pintado moka . Peint couleur moka . Pintado moka

43 Moka plastic . Plastica moka . Plástico moka . Plastique moka . Plástico moka

49 Sand painted . Verniciato sabbia . Pintado arena . Peint couleur sable . Pintado arena

75 Walnut wood . Legno noce . Madera nogal . Bois de noyer . Madeira nogueira



Buller[™]

Buller

20 Woolmer Way Bordon • Hampshire • GU35 9QF (UK)
T. +44 345 004 3748 • T. +44 1420 488 701
www.bullerltd.co.uk • sales@bullerltd.co.uk

emuca

emuca.com

emuca.it • emuca.co.uk • emuca.es • emuca.fr • emuca.pt

Emuca S.R.L.

Via Messico, 80 • 35127 Padova (ITALIA)
T. +39 049 8702800 • F. +39 049 8703019
www.emuca.it • info@emuca.com

Emuca S.A.R.L.

Parc de l'Aubinière • 2 Av. des Améthystes
44338 Nantes Cedex 03 (FRANCE)
T. +33 2 49 88 07 35 • F. +33 2 72 22 02 24
www.emuca.fr • emuca@emuca.com

Emuca Ltd.

75 Springfield Road • Chelmsford • Essex
CM2 6JG (UK)
T. +44 1268 530 674 • F. +44 1268 282 592
www.emuca.co.uk • sales@emuca.com

Emuca Lda.

AV. da Liberdade nº 36, 6º • 01250 Lisboa (PORTUGAL)
T. +351 211 203 940 • F. +34 96 166 71 82
www.emuca.pt • emuca@emuca.com

Emuca S.A.

Pl. El Olival - c/H, 4 • Apartado de correos 176
46394 Ribera-Roja del Túria • Valencia (ESPAÑA)
T. +34 96 166 70 19 • F. +34 96 166 71 82
www.emuca.es • emuca@emuca.com

35
YEARS
GROWING TOGETHER
1981 / 2016

AENOR
E
Empresa
Registrada
UNE-EN ISO 9001
ER-8896/1999

efr
empresa

03/2016 Cod. 900285

UNI EN ISO 9001
CERTIFICADO
SISTEMA DE GESTIÓN DE CALIDAD CERTIFICADO