

opk ROTARY

Furniture Pocket Door

DIE VERSTECKTE TÜR – ELEGANT UND EDEL.
THE HIDDEN DOOR – ELEGANT AND CLASSY.
LA PORTE CACHÉE – ÉLÉGANTE ET CLASSE.

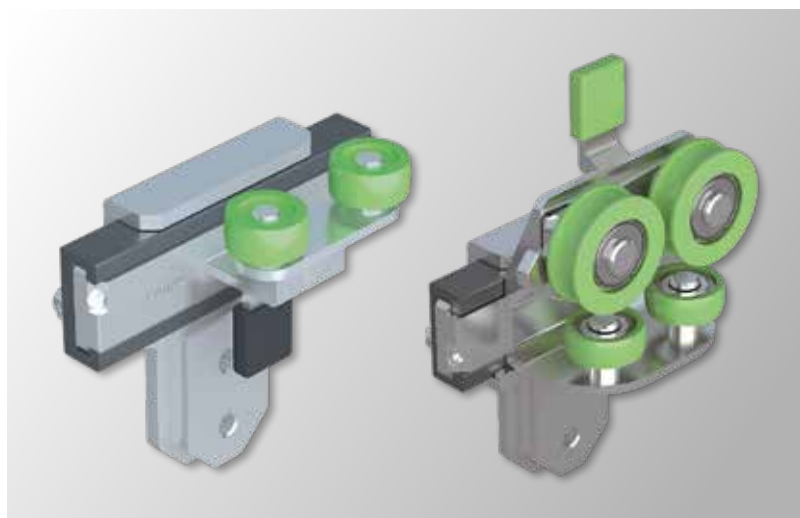
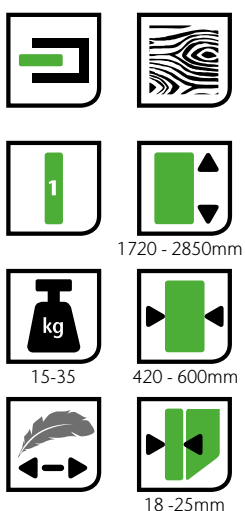

opk Rotary

Furniture Pocket Door



Technische Zeichnung

Technical drawing / Plans et schémas

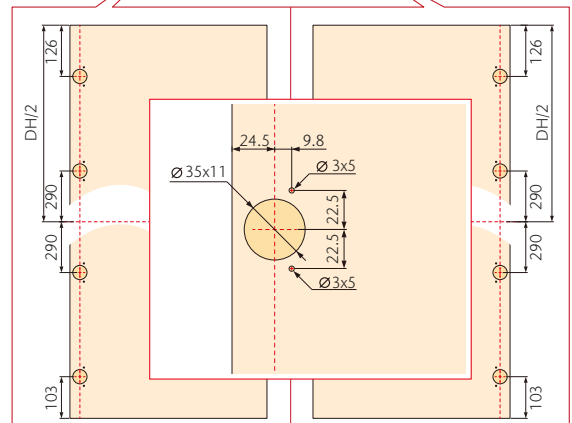
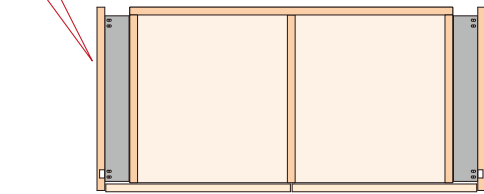
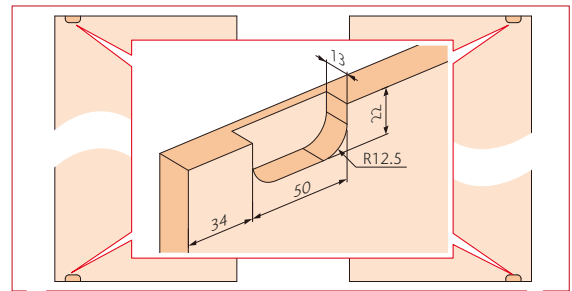
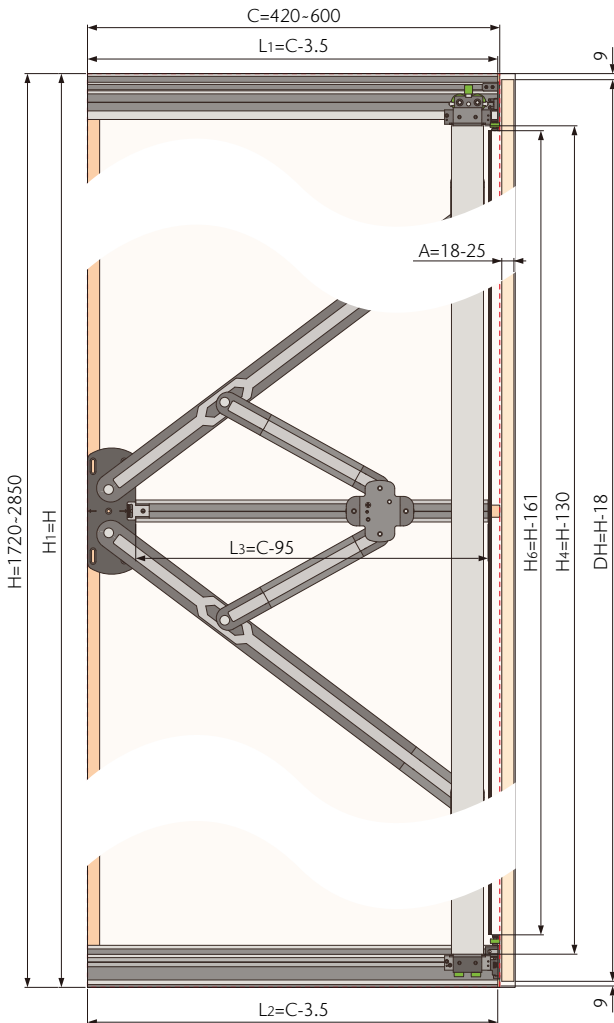
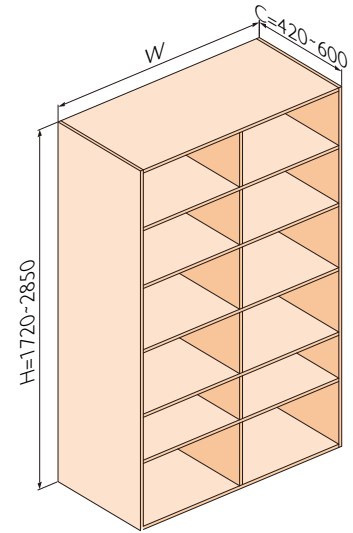
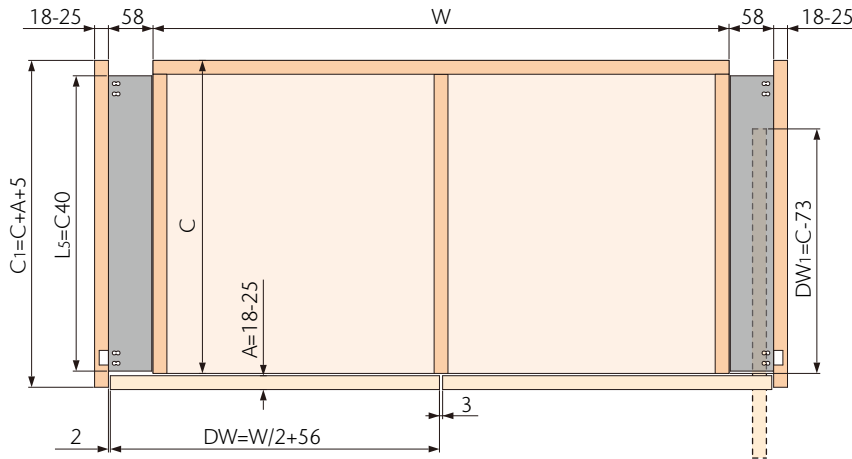

opk Rotary

Furniture Pocket Door



Einzeltür

Single door / Porte simple



Art.-Nr./No./N° d'art.

		15-35	420-600	1720 - 2850	01-010-000-001
--	--	-------	---------	-------------	----------------

Konfiguration für 1 Tür links

Configuration for 1 door left / Configuration pour 1 porte à gauche

Alles drin!
All inclusive!
Tout compris!



Möbel Systeme
Furniture systems /
Systèmes de meubles

Scherenlager <i>Scissor bearings / Palier de ciseaux</i>		1	Dämpfung oben <i>Upper roller with damper / Amortissement en haut</i>		1
Führungsrolle <i>Leadership role / Galet de guidage</i>		2	Dämpfung unten <i>Bottom roller with damper / Amortissement en bas</i>		1
Topfscharnier mit Grundplatte <i>Concealed hinge with base plate / Charnière à boîtier avec sa plaque de base</i>		4	Fixierungs- platte <i>Bracket fixed plate / Plaque de fixation</i>		1
Türöffner <i>Door opener / Ouvre-porte</i>		1	Verbindungs- profil <i>Conneted plate / Profil de connexion</i>	 540 mm	2
Obere Führung links <i>Upper plug-left / Guidage supérieur à gauche</i>		1	Bohrschablone <i>Drilling pattern / Gabarit de perçage</i>		1
Untere Führung links <i>Bottom plug-left / Guidage inférieur à gauche</i>		1	Fixierung Kunststoff <i>Plastic fixed part / Fixation plastique</i>		6
Laufwagen oben links <i>Upper roller-left / Chariot en haut à gauche</i>		1	Abdeckung links <i>Cover left / Cache décoratif à gauche</i>		1
Laufwagen unten links <i>Bottom roller-left / Chariot en bas à gauche</i>		1	Führungshilfe links <i>Guiding aid on the left / Aide au guidage à gauche</i>		1

opk Rotary

Furniture Pocket Door



Einzeltür

Single door / Porte simple



Art.-Nr./No./N° d'art.

		15-35	420-600	1720 - 2850	01-010-000-002
--	--	-------	---------	-------------	----------------

Konfiguration für 1 Tür rechts

Configuration for 1 door right / Configuration pour 1 porte droite

Alles drin!
All inclusive!
Tout compris!



Scherenlager <i>Scissor bearings / Palier de ciseaux</i>		1	Dämpfung oben <i>Upper roller with damper / Amortissement en haut</i>		1
Führungsrolle <i>Leadership role / Galet de guidage</i>		2	Dämpfung unten <i>Bottom roller with damper / Amortissement en bas</i>		1
Topfscharnier mit Grundplatte <i>Concealed hinge with base plate / Charnière à boîtier avec sa plaque de base</i>		4	Fixierungsplatte <i>Bracket fixed plate / Plaque de fixation</i>		1
Türöffner <i>Door opener / Ouvre-porte</i>		1	Verbindungsprofil <i>Conneted plate / Profil de connexion</i>		2
Obere Führung rechts <i>Upper plug-right / Guide supérieur à droite</i>		1	Bohrschablone <i>Drilling pattern / Gabarit de perçage</i>		1
Untere Führung rechts <i>Bottom plug-right / Guidage inférieur à droite</i>		1	Fixierung Kunststoff <i>Plastic fixed part / Fixation plastique</i>		6
Laufwagen oben rechts <i>Upper roller-right / Chariot en haut à droite</i>		1	Abdeckung rechts <i>Cover right / Cache décoratif à droite</i>		1
Laufwagen unten rechts <i>Bottom roller-right / Chariot en bas à droite</i>		1	Führungshilfe rechts <i>Guiding aid on the right / Aide au guidage à droite</i>		1





opk Rotary

Furniture Pocket Door

Schienen, Zubehör im Kit enthalten

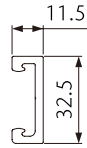
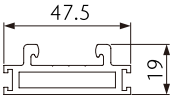
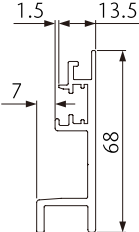
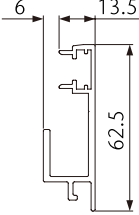
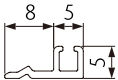
Tracks, Accessories included in the kit / Rails, Accessoires inclus dans le kit

Produktbeschreibung <i>Product description / Description du produit</i>		Material <i>Material / Matériel</i>	Farbe <i>Finish / Couleur</i>	Länge (mm) <i>Length / Longueur</i>	Art.-Nr./No./ N° d'art.
Führungsprofil Mitte <i>Middle track / Guidage au milieu</i>		Aluminium-legierung <i>Aluminum Alloy / Alliage d'aluminium</i>	Eloxiertes Silber <i>Anodized Silver / Argent anodisé</i>	505	01-010-000-003
Achsführung Mitte <i>Middle axle / Guidage d'essieu au milieu</i>		Aluminium eloxiert <i>Anodized aluminium / Argent anodisé</i>	Eloxiertes Schwarz <i>Anodized Black / Noir anodisé</i>	2716	01-010-000-004
Oberes Führungsprofil <i>Upper track profile / Guidage supérieur</i>		Aluminium-legierung <i>Aluminum Alloy / Alliage d'aluminium</i>	Eloxiertes Silber <i>Anodized Silver / Argent anodisé</i>	596.5	01-010-000-005
Unteres Führungsprofil <i>Bottom track profile / Guidage au sol</i>		Aluminium-legierung <i>Aluminum Alloy / Alliage d'aluminium</i>	Eloxiertes Silber <i>Anodized Silver / Argent anodisé</i>	596.5	01-010-000-006
Profil Dichtungsbürste <i>Profile for weather strip / Brosse d'étanchéité de profil</i>		Aluminium eloxiert <i>Anodized aluminium / Argent anodisé</i>	Eloxiertes Schwarz <i>Anodized Black / Noir anodisé</i>	2720	01-010-000-007
10x5mm Dichtungsbürste <i>10x5mm weather strip / Brosse d'étanchéité</i>		Kunststoff <i>Plastic / Plastique</i>	Grau <i>Gray / Gris</i>	2720	01-010-000-009

opk Rotary

